

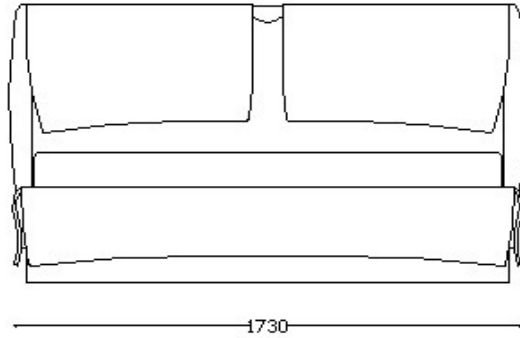

ΚΡΕΒΑΤΟΚΑΜΑΡΑ ΝΑΥΣΙΚΑ

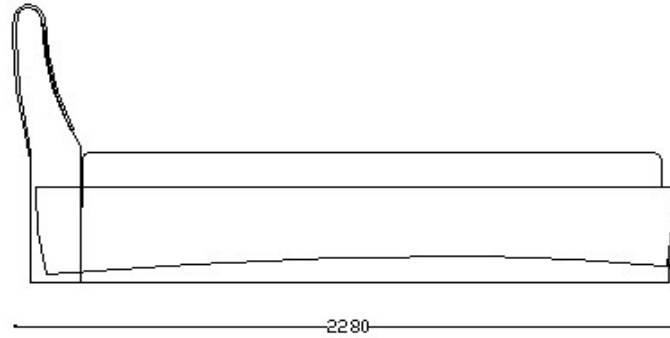

1730



2280

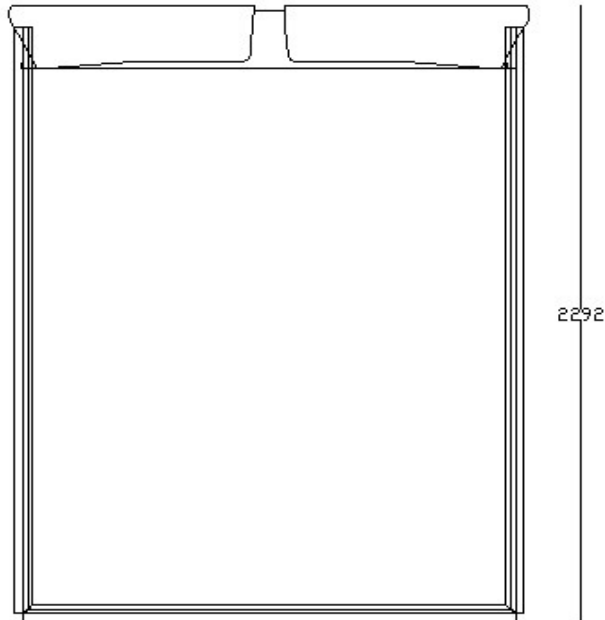

2292

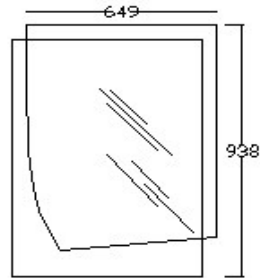

649

938

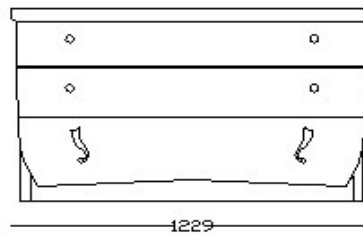

1229

720

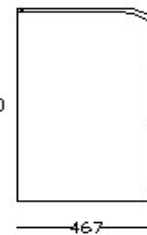

467

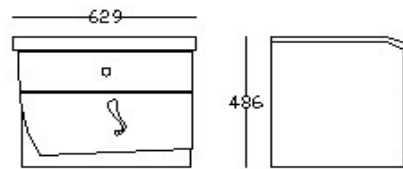

629

496

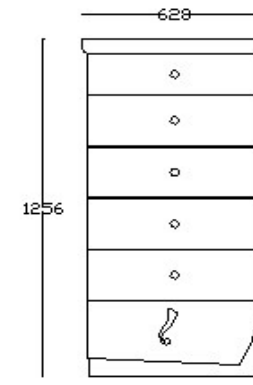
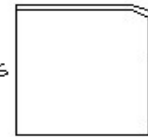

628

1256

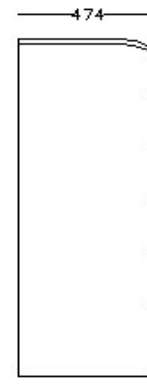

474



КРЕВАТОКАМАРА ВЕРГИНА

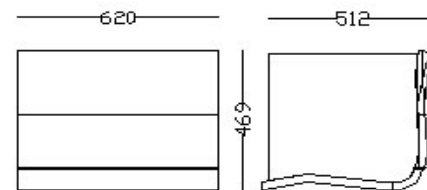
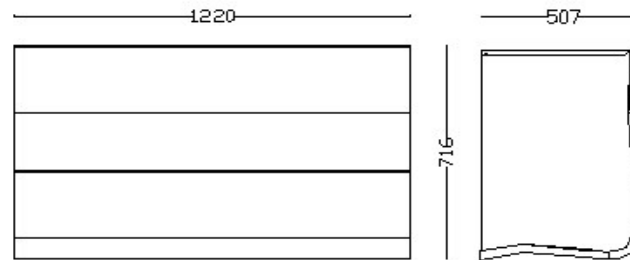
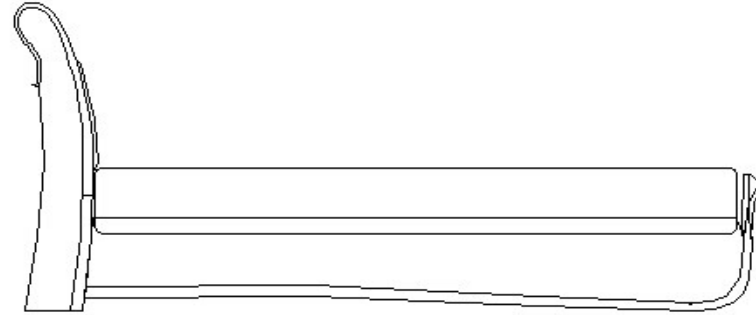
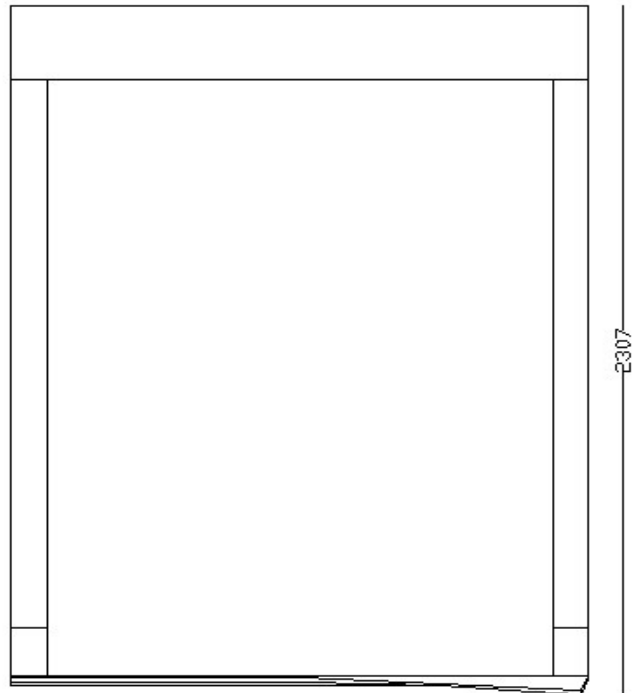
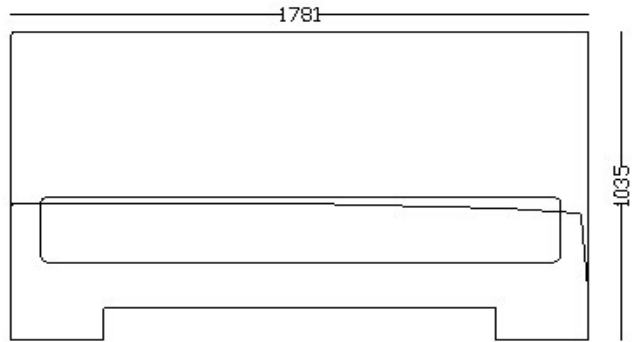



ΚΡΕΒΑΤΟΚΑΜΑΡΑ ΕΛΠΙΣ

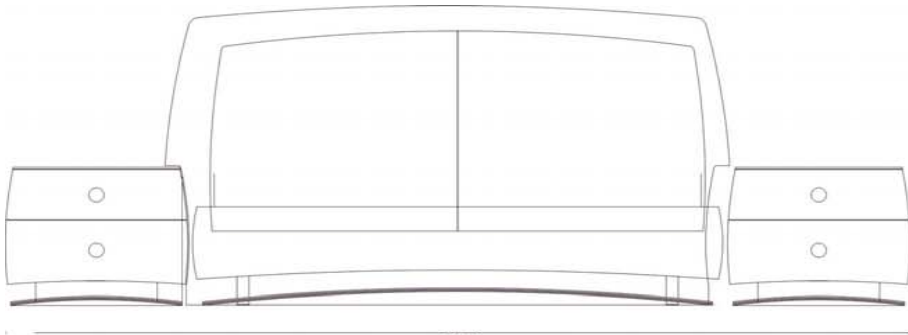

2972



1066

488

2224

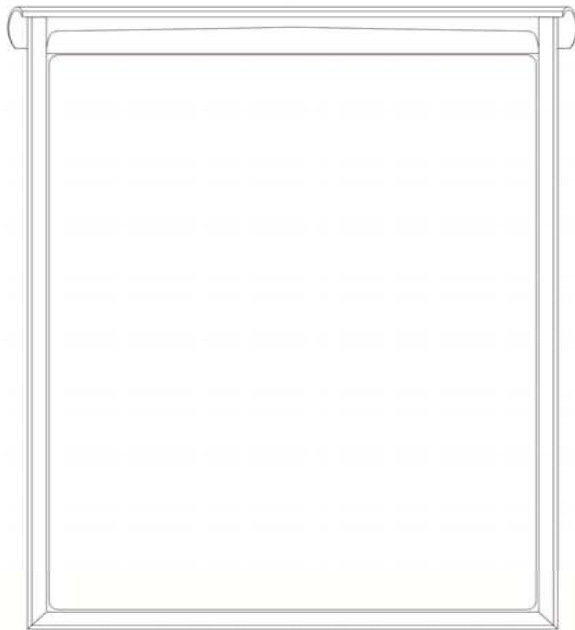

1742

2206

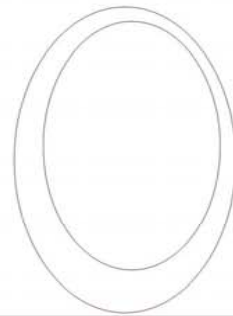

1087

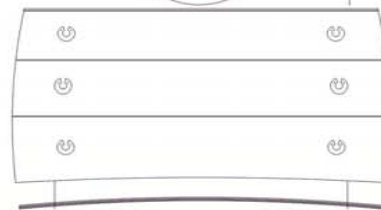

1240

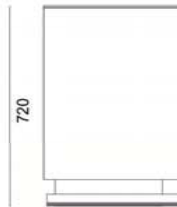

720

470

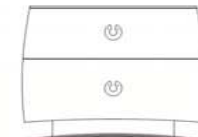

600

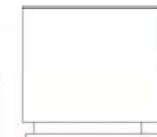

480

470



КРЕВАТОКМАРА HBH

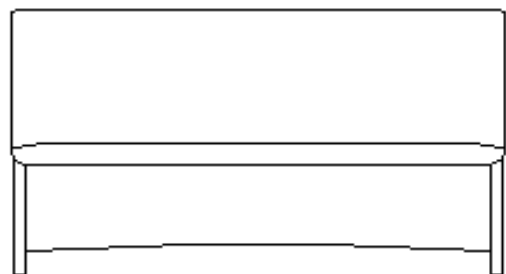

1720

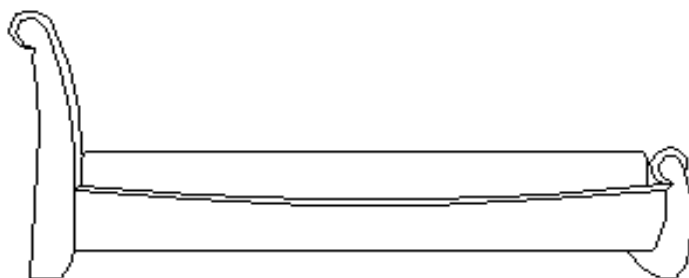

2380

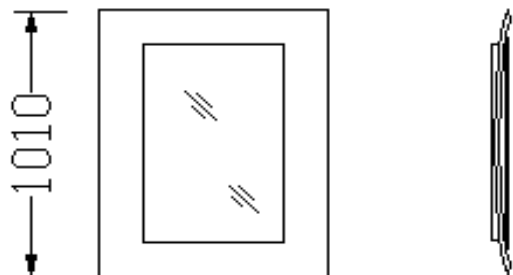

1010

800

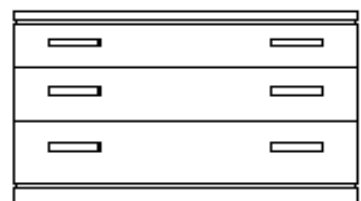

1200

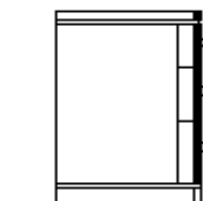

505

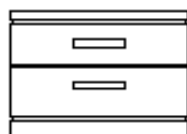

620

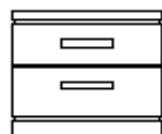

520

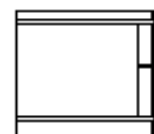

495

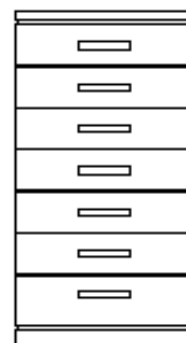

620

1266



ΚΡΕΒΑΤΟΚΑΜΑΡΑ ΛΗΤΩ

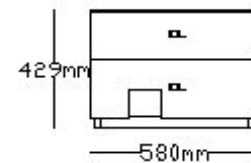
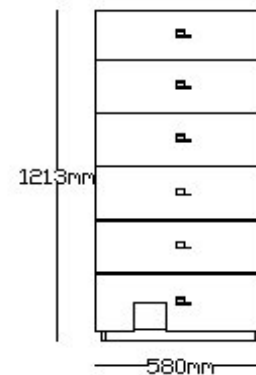
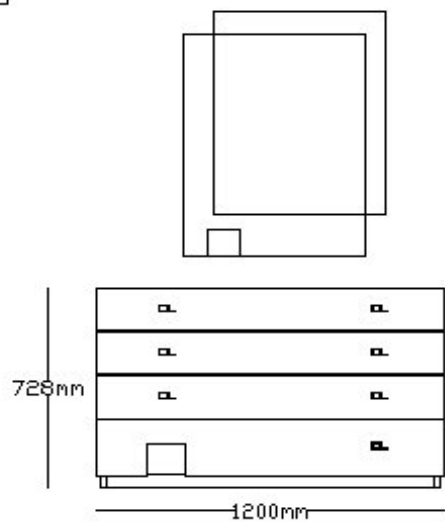
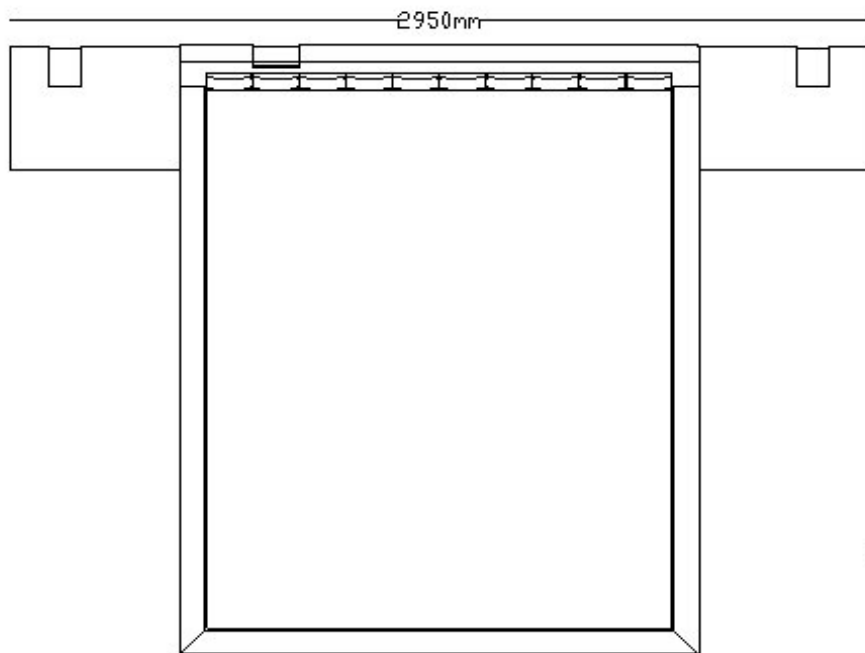
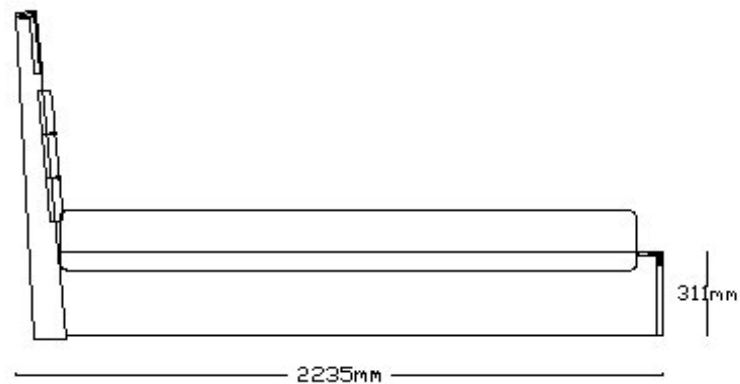
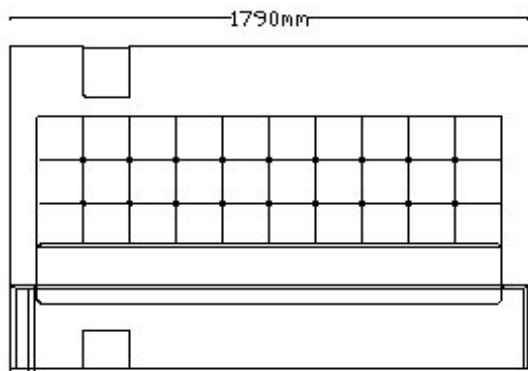



ΚΡΕΒΑΤΟΚΑΜΑΡΑ ΜΠΑΡΟΚ

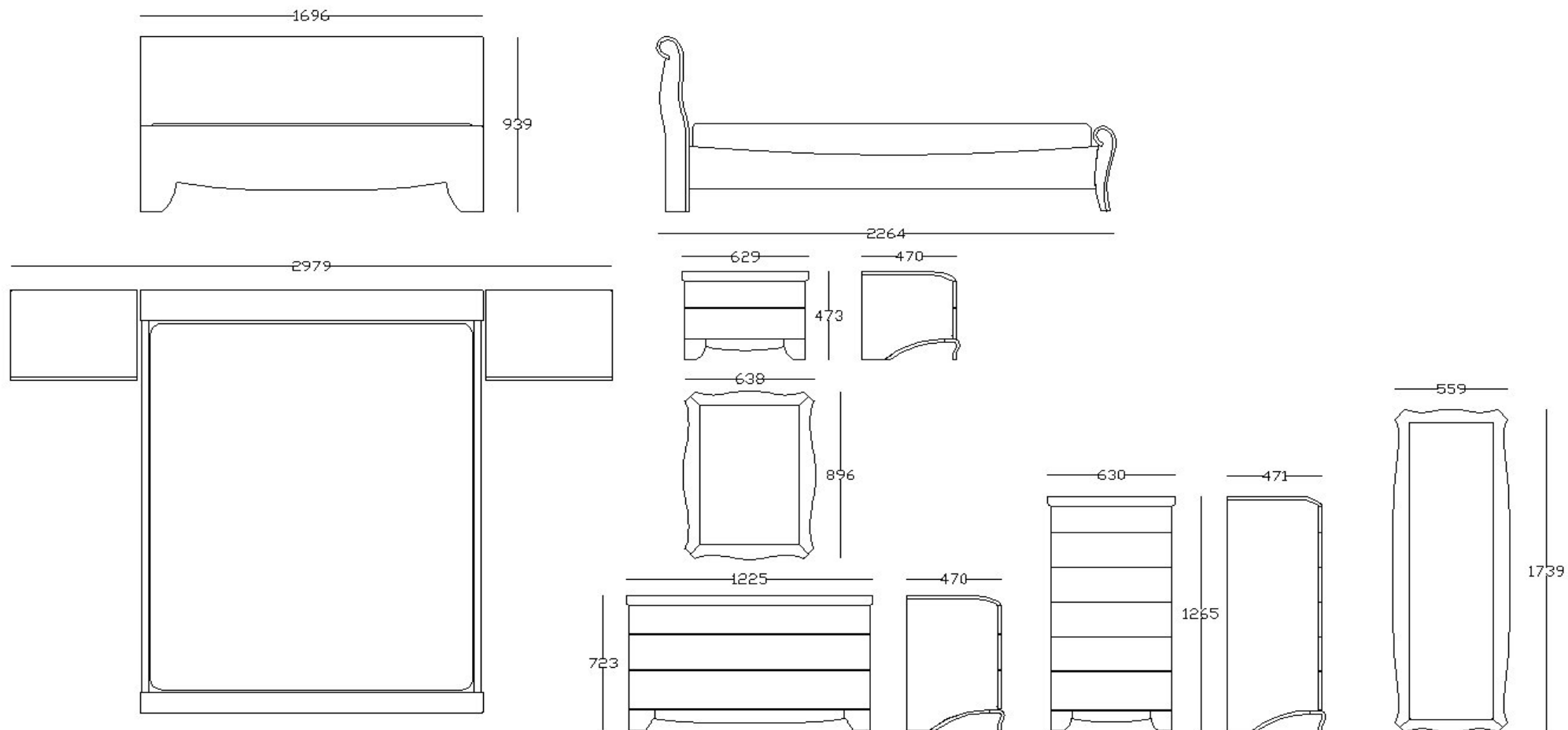



ΚΡΕΒΑΤΟΚΑΜΑΡΑ ΣΑΡΑ

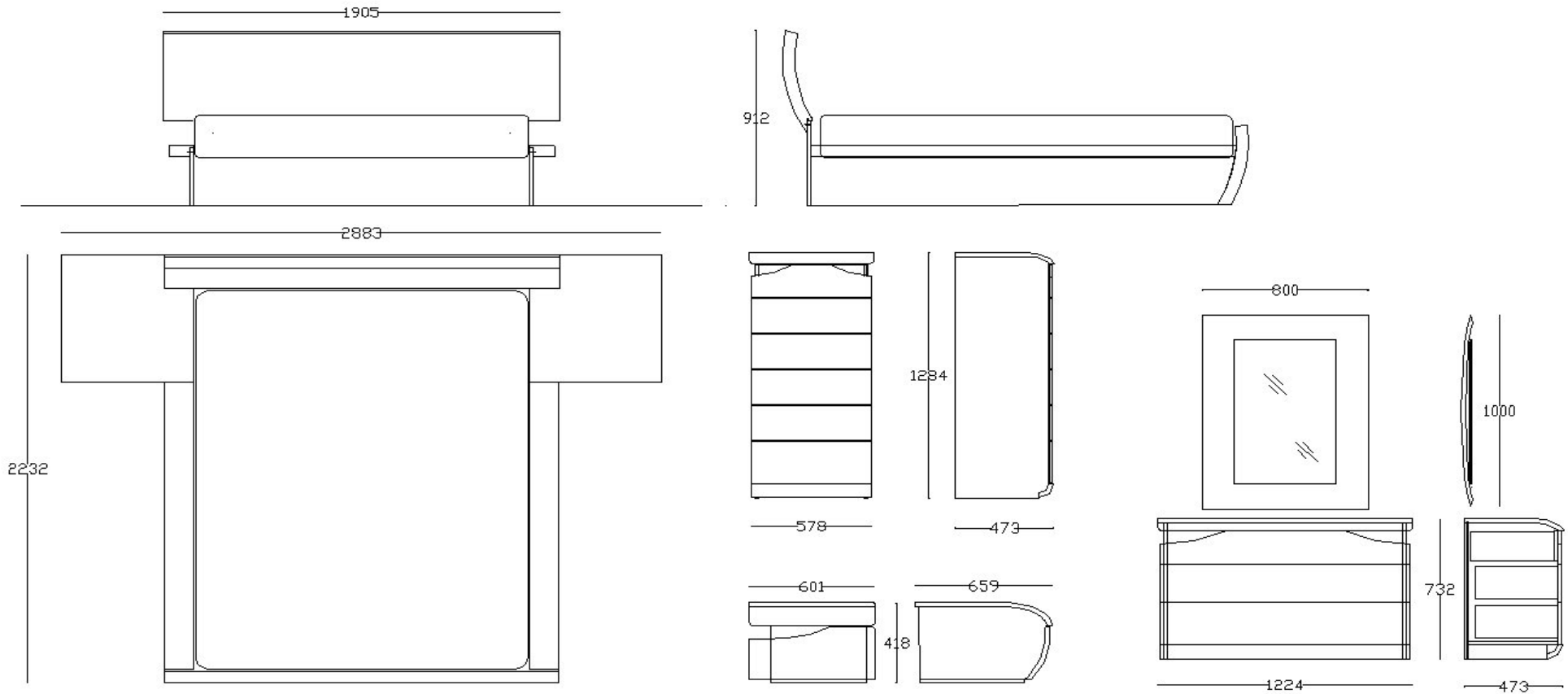



ΚΡΕΒΑΤΟΚΑΜΑΡΑ ΛΑΙΣ

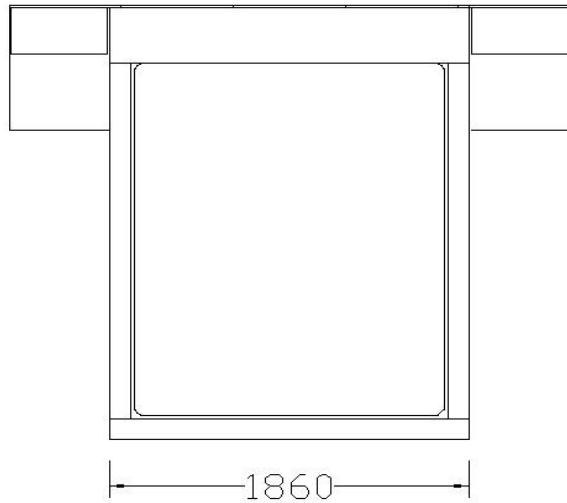
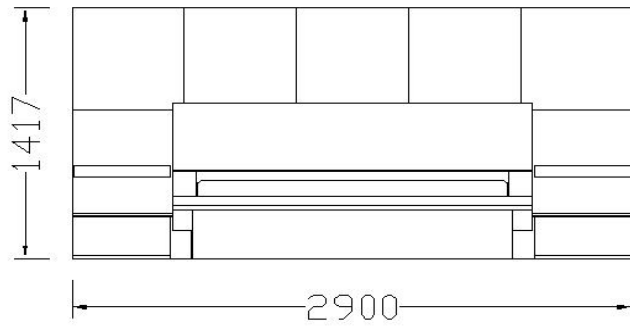

Αποθηκευτικός πίσω
από το κεφαλάρι

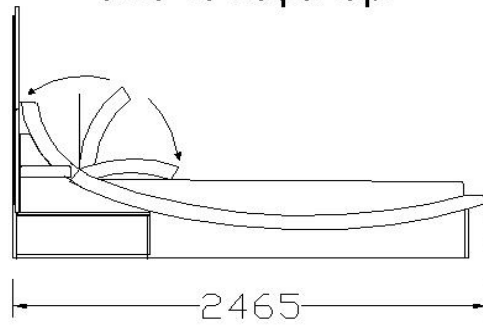

Αποθηκευτικός κάτω
από το στρώμα

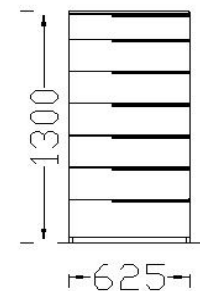
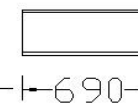
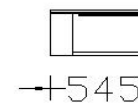
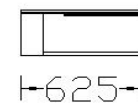
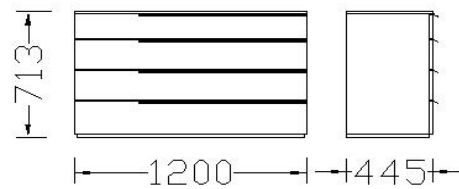
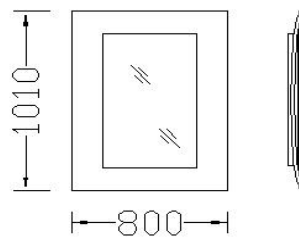
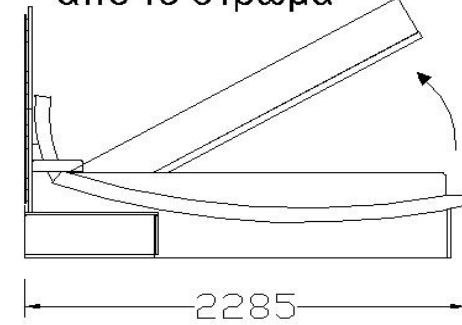



ΣΤΑΔΙΑ ΣΥΝΑΡΜΟΛΟΓΗΣΗ ΛΑΪΣ

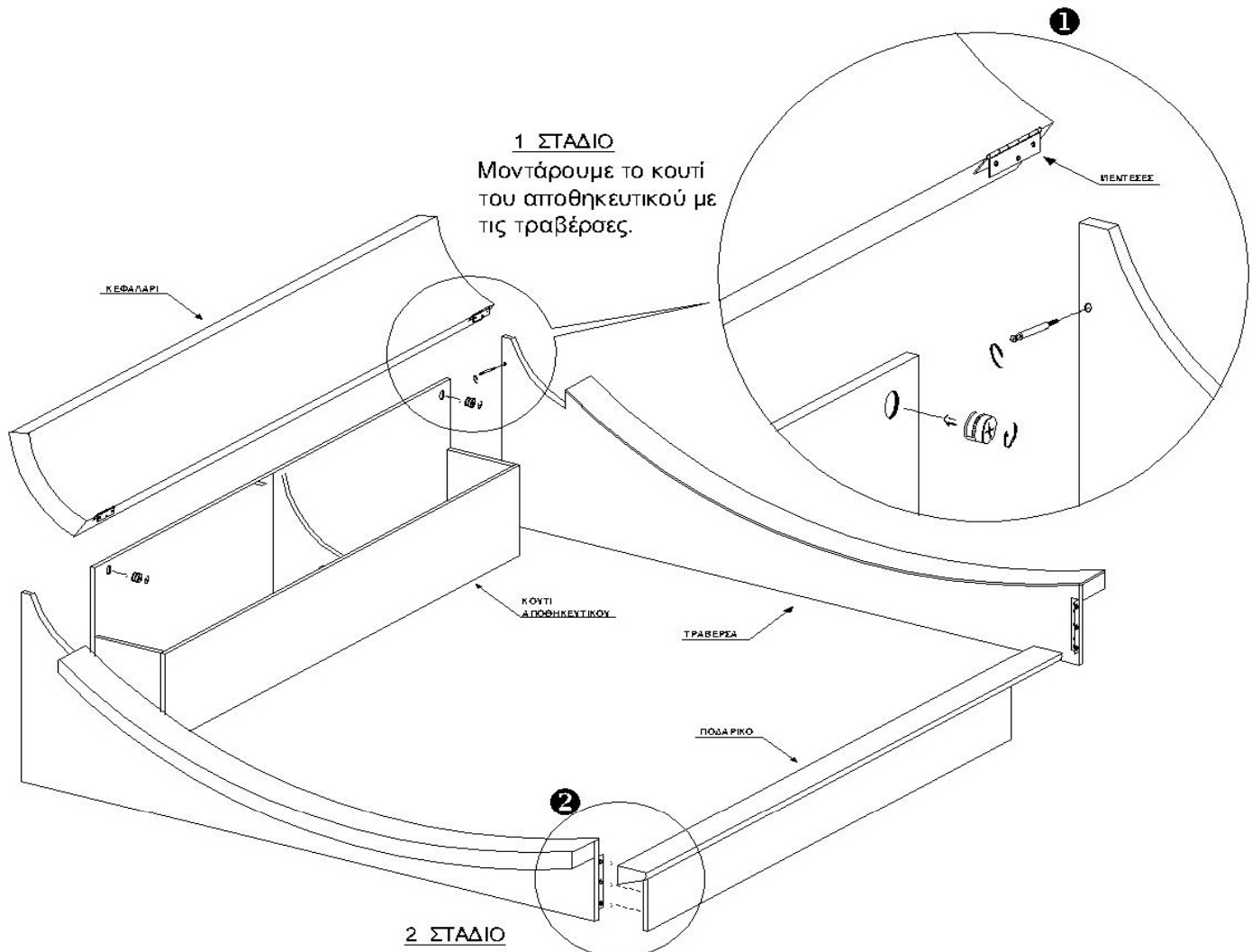

2 ΣΤΑΔΙΟ

Μοντάρουμε το ποδαρικό με τις τραβέρσες.

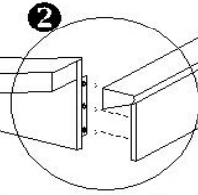

3 ΣΤΑΔΙΟ

Μοντάρουμε το κεφαλάρι με τις τραβέρσες.
(Το κεφαλάρι πρέπει να ακουμπάει στο στρώμα για να μονταριστεί, βλέπε εικ.3)

ΤΟΡΟΣ

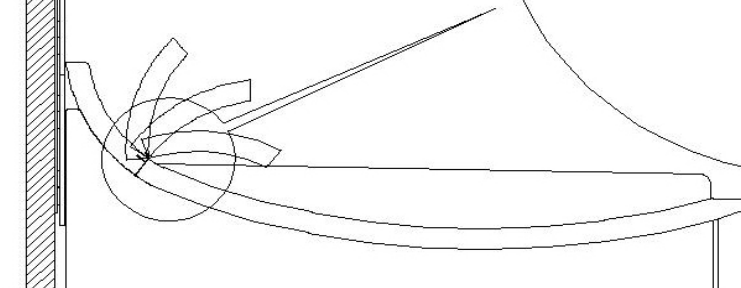
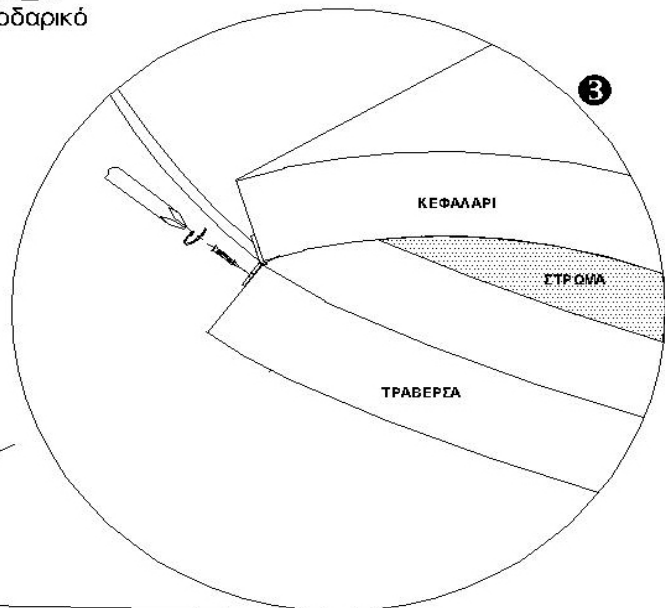



ΣΥΝΑΡΜΟΛΟΓΗΣΗ ΤΑΜΠΛΑΔΩΝ ΛΑΪΣ

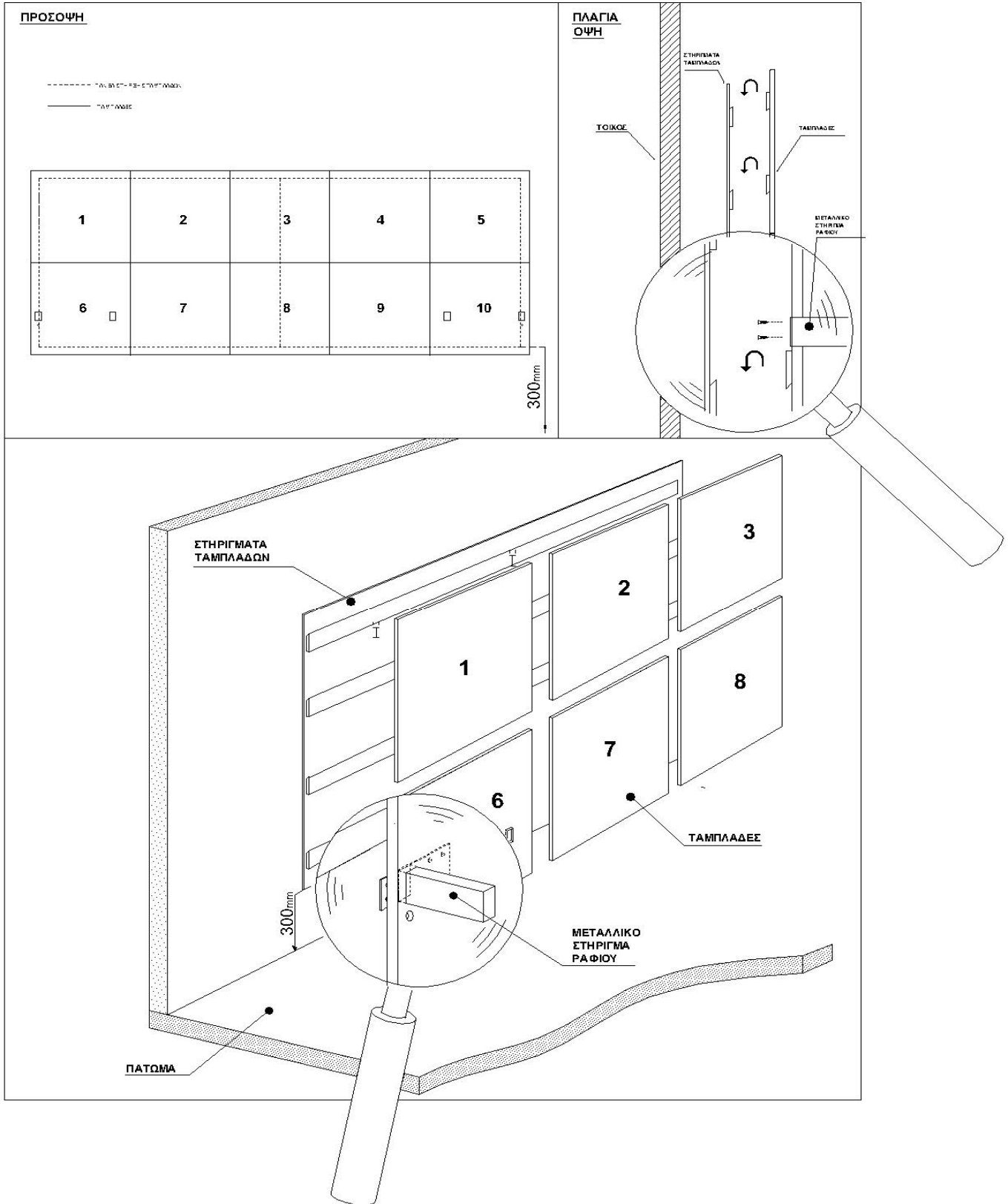



ΤΡΑΠΕΖΑΡΙΑ ΘΕΤΙΣ

